



Testing in IEC 61850-based PACS

Focus on Maintenance Testing Isolation

JUN VERZOSA & NESTOR CASILLA
Doble Engineering Company

UCAIug IEC 61850 IOP 2019
2019 September 22

Electric Power Research Institute
Charlotte, North Carolina, USA

Secure and Efficient Testing of IEC 61850-Based Protection and Control Systems



Agenda

What are the challenges during testing

(focus on maintenance testing)

Requirements for testing IEC 61850-based PACS

Doble's simulation test devices and software tools

- “**Software switches**” replace conventional physical test switches for **isolating injected signals and outputs** of device under test (DUT) from the rest of the system in normal service
- Test signals (SV and GOOSE) are seen by DUT as well as devices in normal service – a **major security concern**
- Test Isolation features of IEC 61850 are **not understood** by most testers
- Similar GOOSE messages from Test Sets and Real IEDs (under test and in normal service) are **difficult to be differentiated** by testers and by some IEDs (Edition 1)
- Existing **packet sniffing tools** are **difficult to use for data visualization** by testers
- Issuing of **control sequences** through MMS client is **extremely difficult** from the data model IED explorer tree and list views
- How to prepare the IEDs for testing
- A complete substation and its system configuration description file (SCD) can contain **100s of IEDs** and it is difficult to manage the test scenarios without errors
- Configuring some complex tests is often times a **trial-and-error** process
- **No room for errors** when doing maintenance **testing in a live substation**

- A single IED can have **numerous** protection & control functions
- Many functions can share a **common trip output**. How to test a specific protection element (e.g., Zone 2 AB loop, Neutral OC stage 2, etc.) if the **element of interest is not in the dataset**
- **Not allowed to change** protection settings or re-map I/O signals for maintenance
- Some schemes have functional elements that are **distributed across multiple physical IEDs**
- Some protection functions require 2 or more simultaneous sets of sampled values
- Some **hybrid systems** use both conventional voltages and currents and sampled values

Testing Requirements and Doble Solutions



- Import SCL files; read data model and configuration from IEDs; compare files
- Scan network for GOOSE & SV messages
- Mask complexity of IEC 61850 from user
- Easy setup of test configuration for SV publishing and GOOSE subscription and publishing.
- Real-time data visualization
 - Tabular list of selected signals
 - Annunciator panel with widgets
 - Oscillography (SV, GOOSE, Reports)
- Record SV and data (GOOSE, Reports) in COMTRADE files; Viewer/Analysis module
- Logging of GOOSE, Report and Polling data
- User-friendly MMS Client w/ descriptive semantic information
- Easy-to-use interface for
 - control of breakers and other controllable objects
 - preparing the IEDs for simulation and testing
- GOOSE simulator for publishing and subscription; with programmable logic
- Support IEC 61850 testing features
- Default to secure simulation/quality states
- **Save and re-use** Configuration Setup files and Test Plans that have been fully verified to be working correctly – This **ensures security, avoids errors** during actual testing and **improves efficiency** and management of the testing process

Test Features – **Isolation** during Maintenance



Test signals injected by test set should be:

- **Accepted only** by Devices (*IEDs or Logical devices*) under test (**DUT**)
- **Rejected** by devices that are in **normal service**

Simulation:

- Test set publishes SV and GOOSE messages with **Simulation flag = true**
- **DUT set to Simulation** will process messages with Simulation flag = true
- Devices in **normal service** (Simulation not set) will **not process** simulated messages

Output Signals of DUT

- Outputs signals should be **accepted** by other devices also under test
- **rejected** by other devices in **normal service**
- Hard-wired outputs of the DU should be **blocked** from operating on the process

Mode/Behavior: – Test, Test/blocked

- GOOSE outputs of DUT are identified with **q.test=true**. They are **processed as valid** by other devices also **under test**
 - Devices in **normal service** reject (or **process as Invalid**) signals with q.test=true.
- Test/blocked mode: Physical outputs **blocked**

IEC 61850 Test Simulation Features (Edition2)

IEC 61850 Test Set

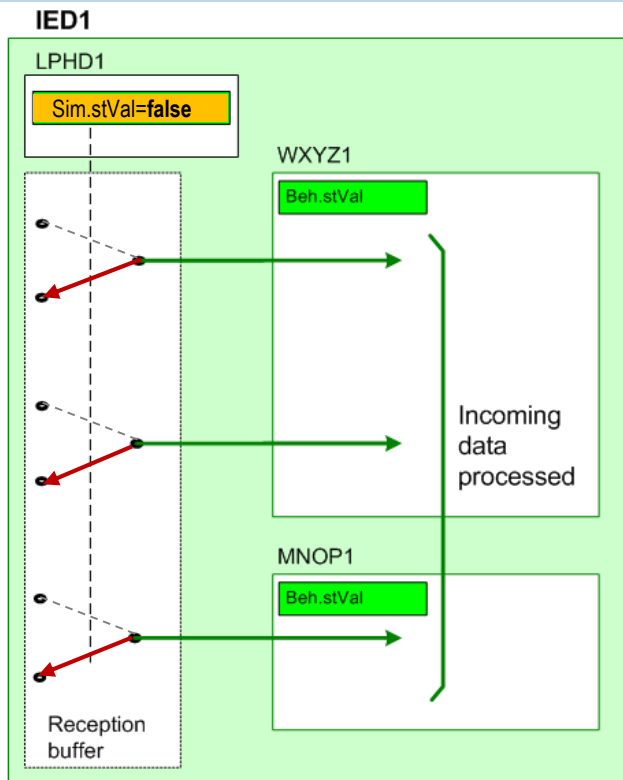
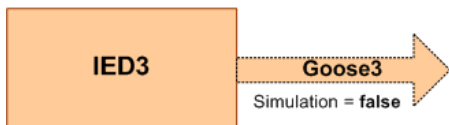
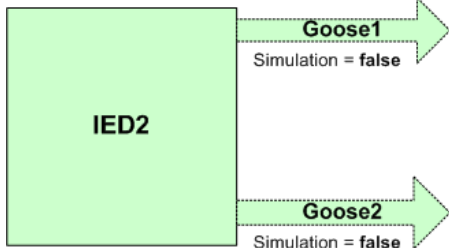

- Devices in normal service with Simulation=**false** will process GOOSE messages from real IEDs

IEC 61850 Test Simulation Features (Edition2)

IEC 61850 Test Set

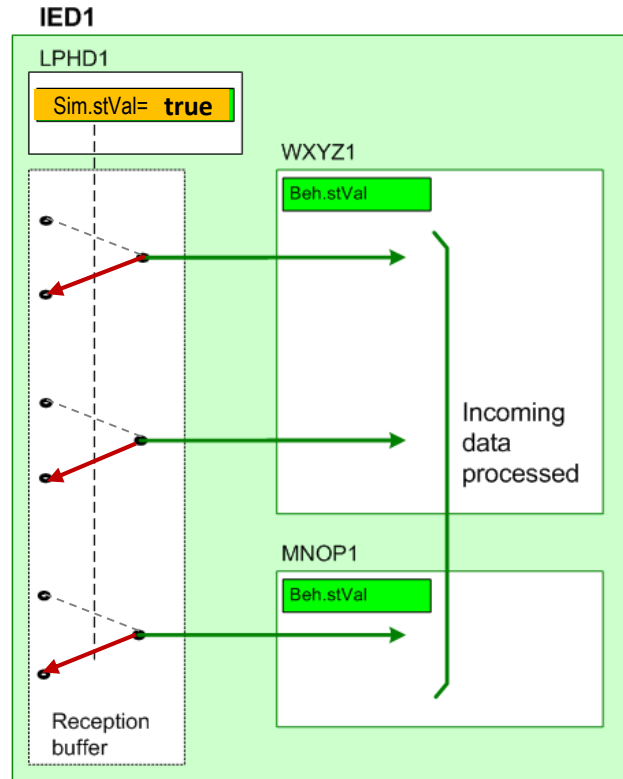
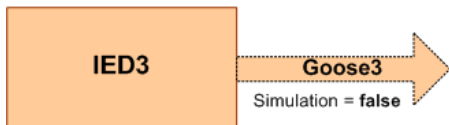
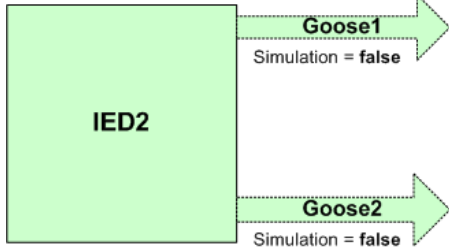

- Devices in normal service with Simulation=**false** will process GOOSE messages from real IEDs
- Device with Simulation changed to **true** will still continue processing GOOSE messages (with simulation flag = false) from real IEDs, if there are **no** simulated messages from the test set

IEC 61850 Test Simulation Features (Edition2)

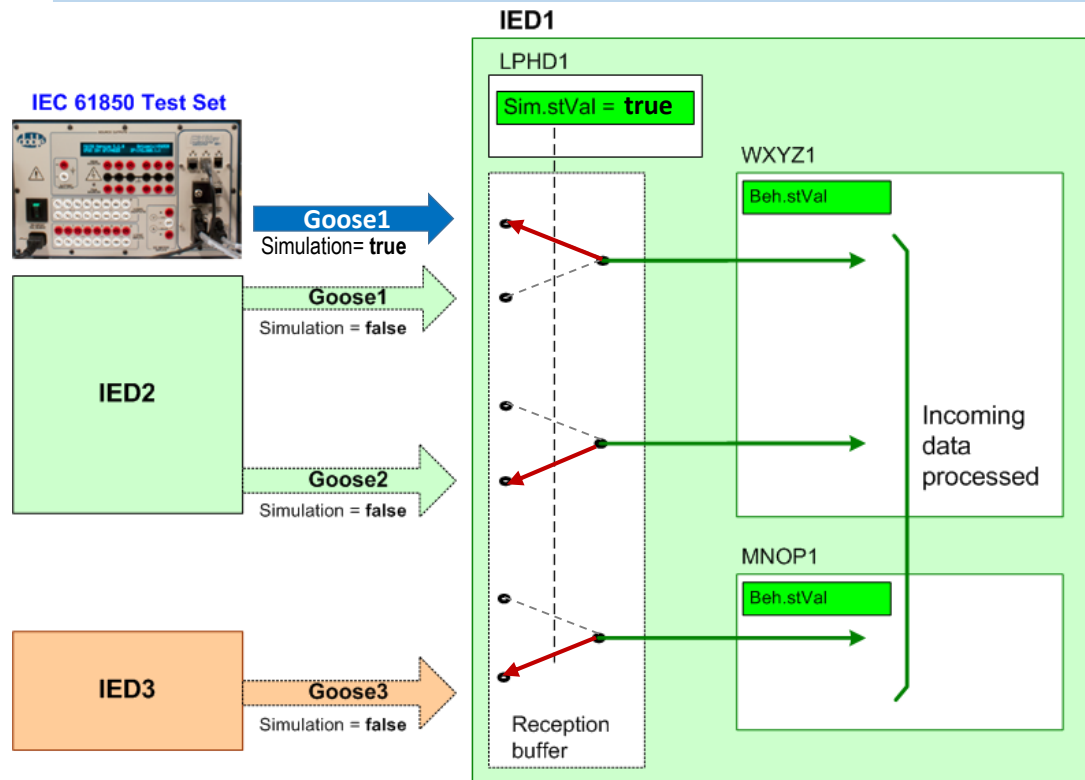

- Test set publishes GOOSE msgs with **Simulation flag = true**
- DUT with Simulation = **true** will
 - Start accepting messages with Simulation flag = **true**
 - **Reject** messages from real IED with Simulation flag = **false**

IEC 61850 Test Simulation Features (Edition2)

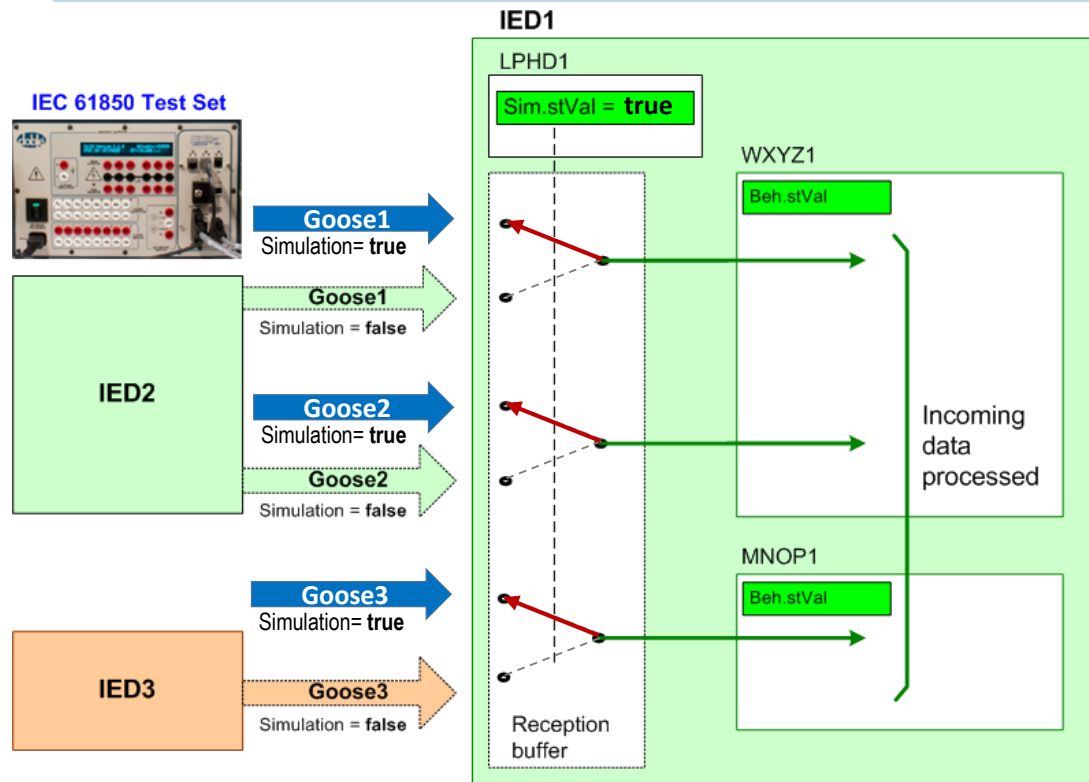

- Test set publishes GOOSE msgs with **Simulation flag = true**
- Devices in Simulation = **true** will **accept** incoming simulated messages with Simulation flag also set to **true**
- All GOOSE messages from the **real IEDs (Sim=false)** that have the same names as the simulated ones will now be **rejected**.

This concept also applies to Sampled Values

Mode and Behavior of Logical Devices and Logical Nodes

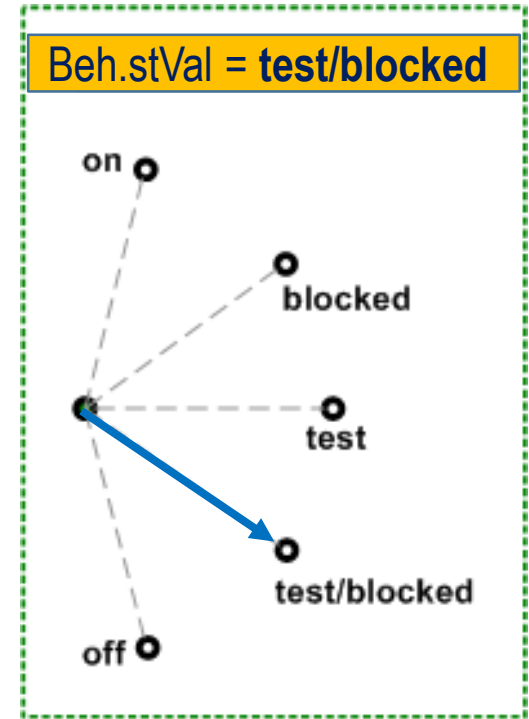
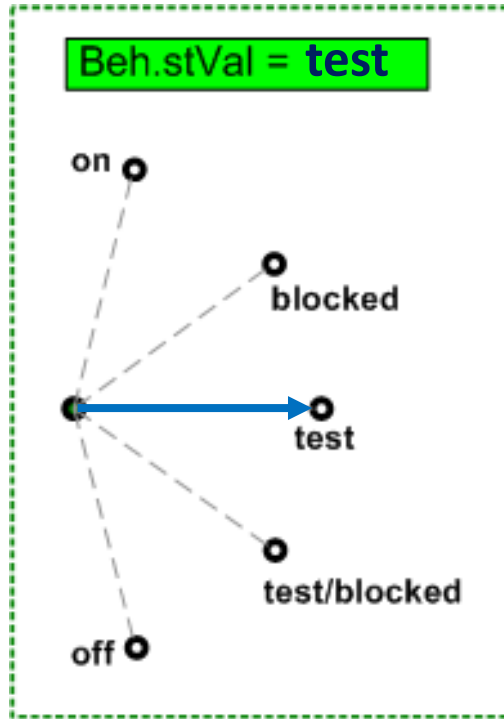
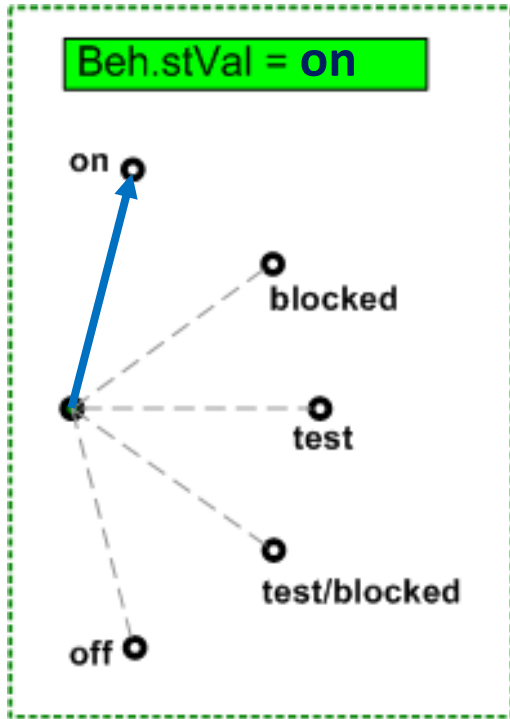

Mode/Behavior, Data Quality and Processing

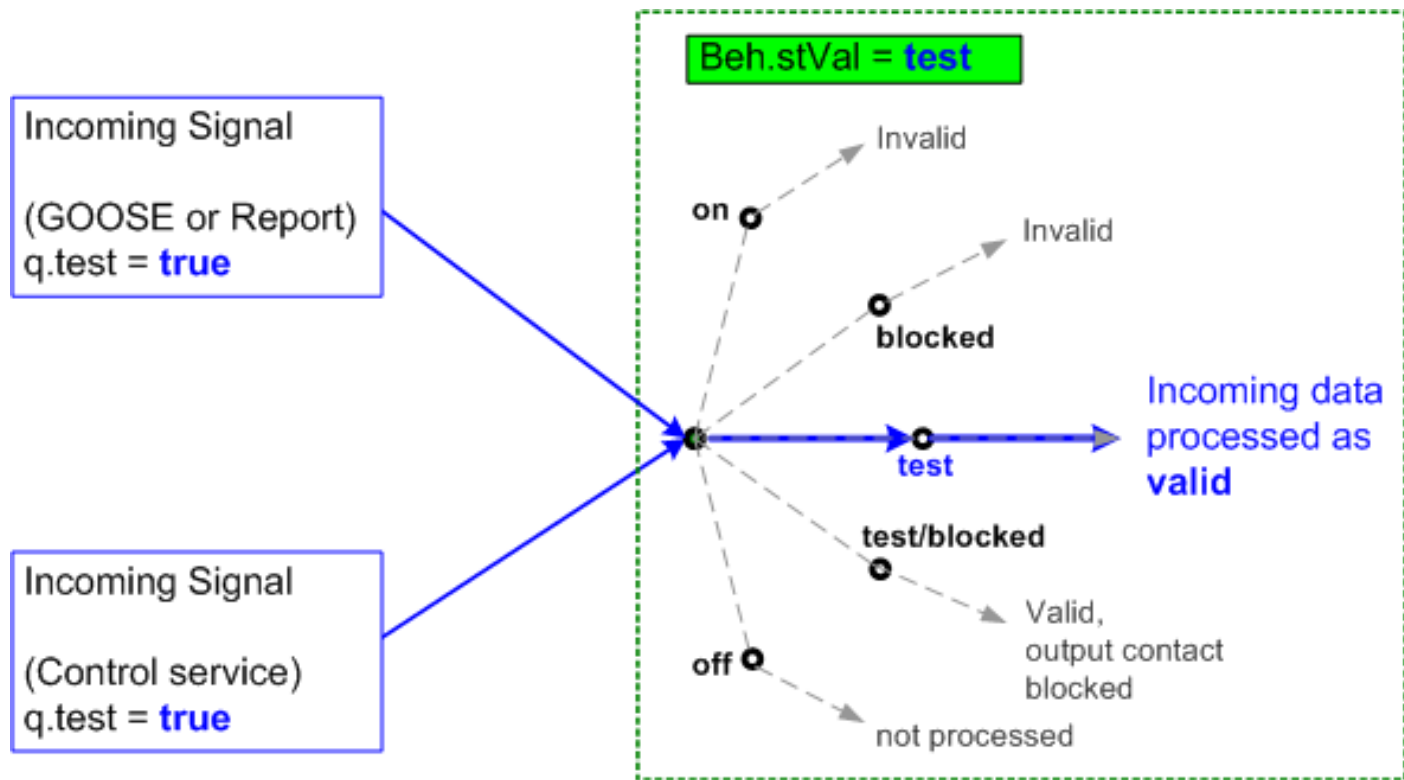

Incoming GOOSE

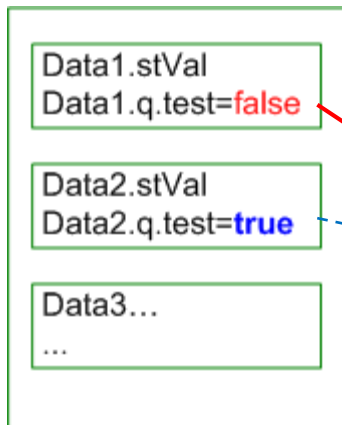

Data items that have *q.test = true* will be processed as **invalid**

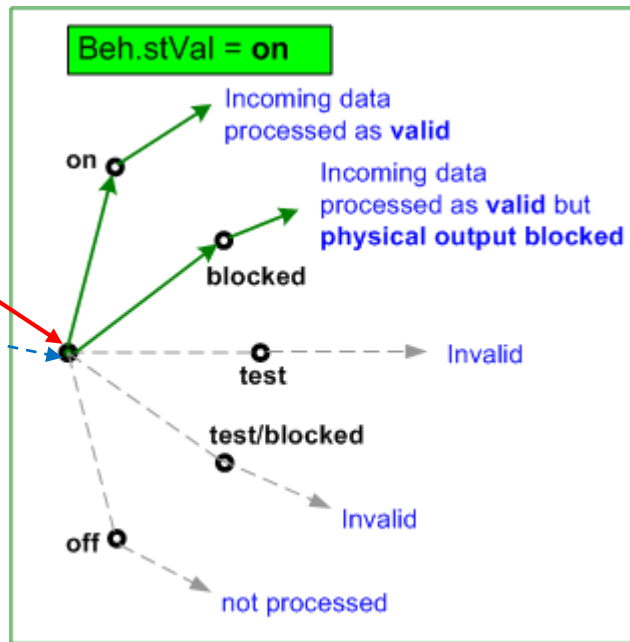

This also applies to Control service messages

- Data items with **q.test=false** (normally from real IEDs) will be **processed as valid**
- DUT/LD with Behavior = **on** will **process as invalid** incoming data with **q.test = true**

Incoming GOOSE

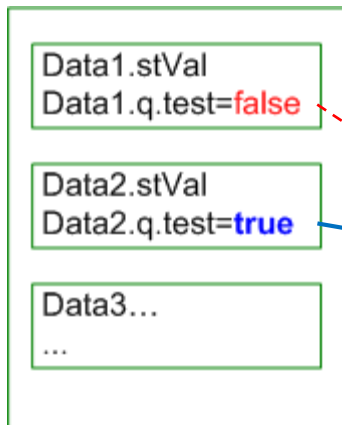

Data items that have *q.test = false* will continue to be processed as **valid** !

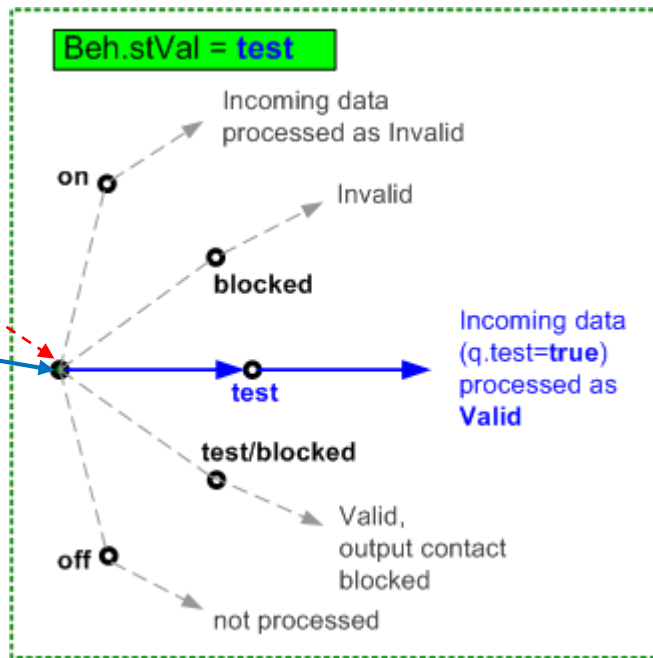

This also applies to Control service parameter Test

- DUT/LD with Behavior = **test** or **test/blocked** will **process as valid** incoming data with **q.test = true**
- Data items with **q.test=false** will be continue to be **processed as valid** !

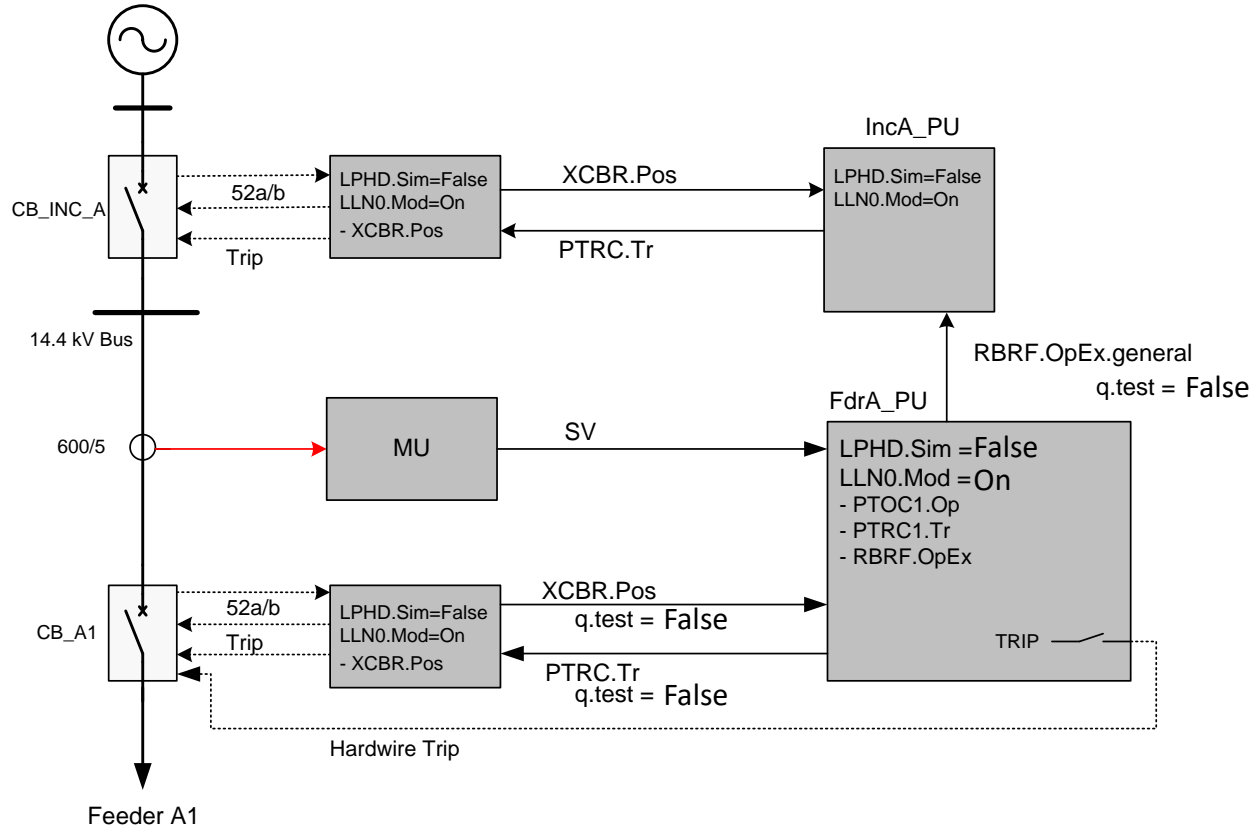

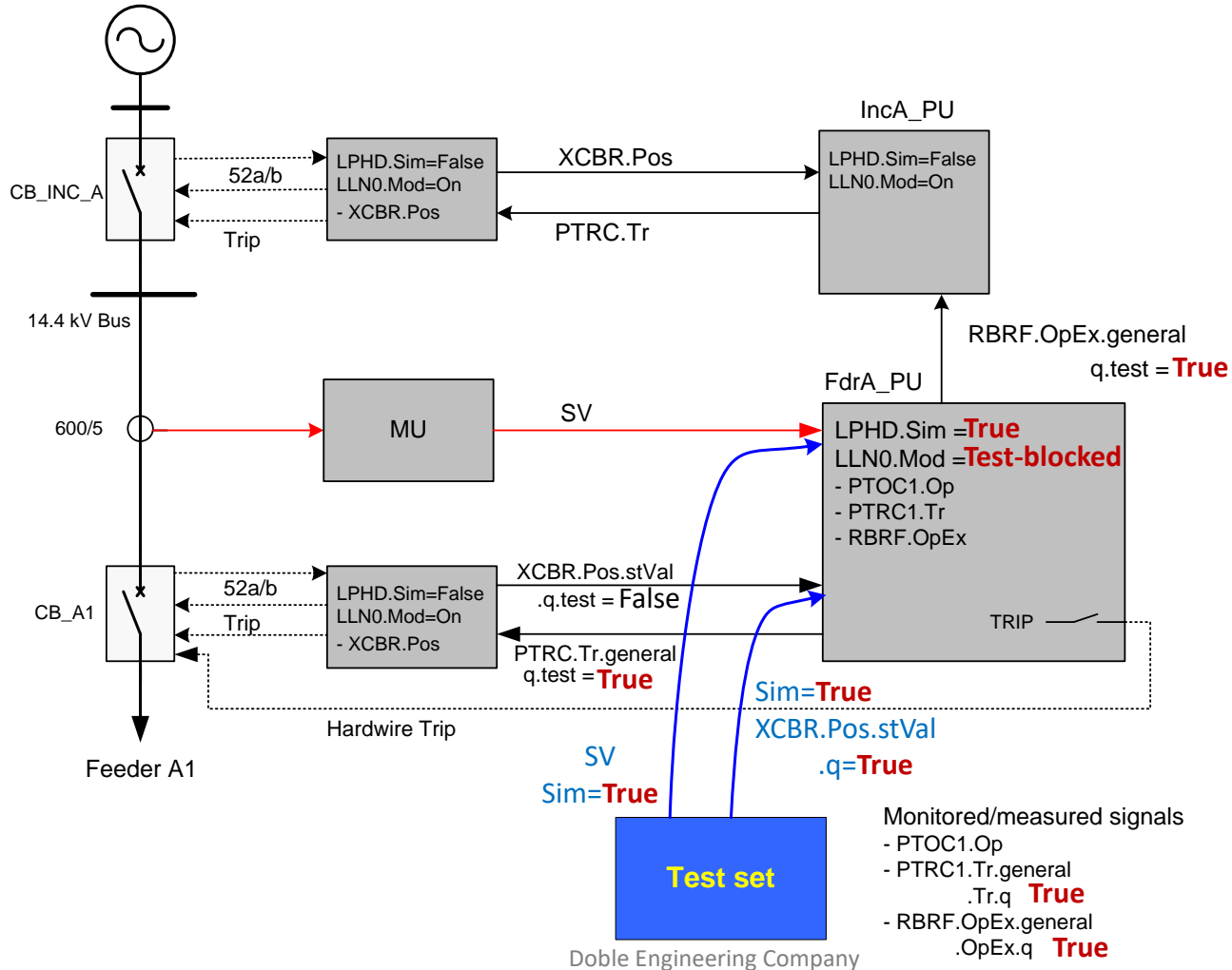

Doble Solutions

for

Testing IEC 61850-based Protection and Control Systems

Tools for Testing IEC 61850-based PACS

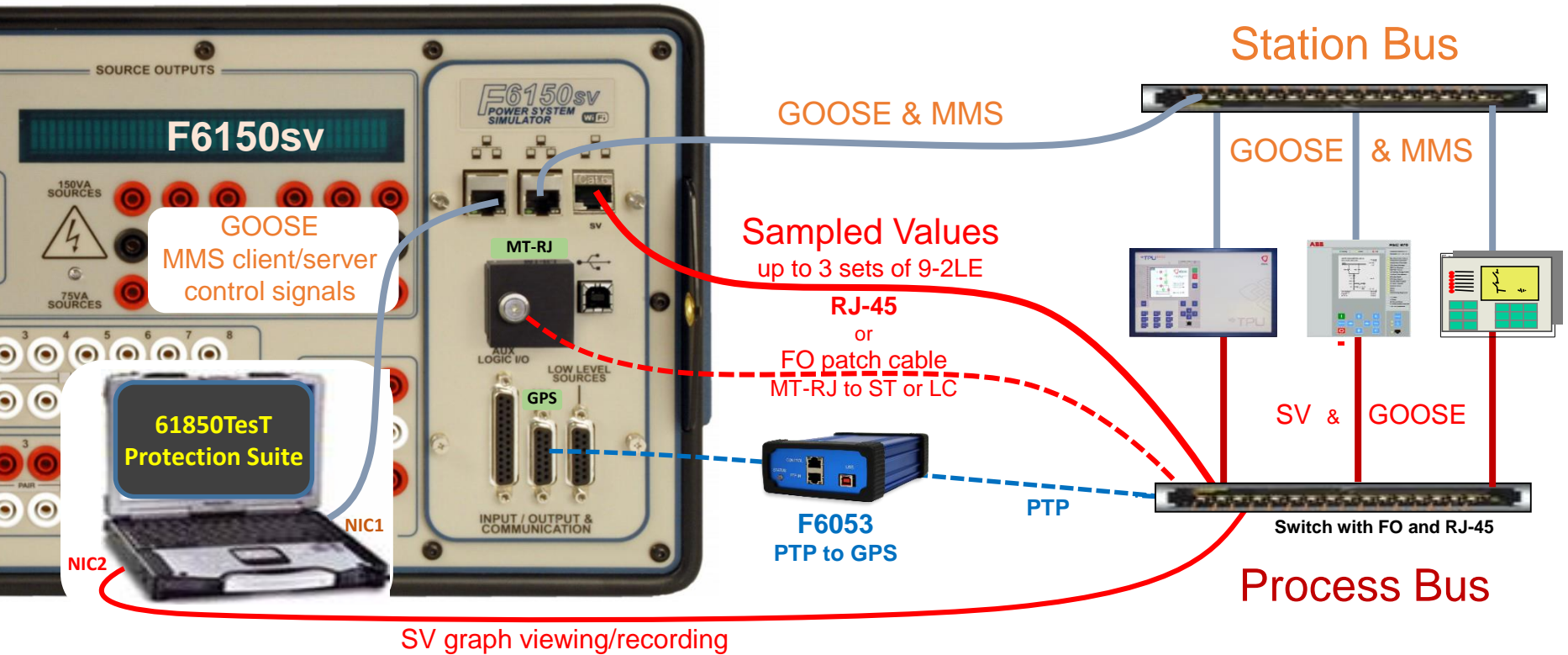

GOOSE Messages and Datasets



- Import SCL file or discover IEDs
- Add custom labels for easy identification, esp. for GGIO data items
- Select data items for
 - Use as Inputs/Outputs
 - Viewing in live data
- For GOOSE simulation
 - Set Sim flags
 - Set data q.bits
 - Verify default data values

The screenshot displays the 'GSE Messages' configuration window. The top menu includes 'Files', 'GSE Messages', 'SV Messages', 'C/S Simulator', 'Live Data', 'Logging', 'COMTRADE', 'Scanning', 'Preferences', 'F6 Instrument', and 'Save'. Below the menu, there are buttons for 'Clear all messages' and 'Send to F6000'. The main area shows a table of GSE messages with columns for IED Name, LD Name, GSE Control Block Reference, Dataset name, GSE Application ID, VLAN ID and Priority, Simulate Bit, Show Live Data, Enable PC Simulation, Select all GN, Select all GP, and Quality Value. A 'Simulate Bit' column is highlighted with a green circle.

Below the GSE Messages table, there are buttons for 'View GSE Configuration Details', 'Compare IEDs', 'Discover via Client', and 'Load to PC GSE Simulator'. The 'Dataset items' section shows a table with columns for Dataset Items, Data type, Default Value, Details from SCL file, Custom label, I/O Usage (GN, Use, GP, Use), and Show live d. The 'Default Value' column and the 'Show live d.' column are highlighted with red boxes.

IED Name	LD Name	GSE Control Block Reference	Dataset name	GSE Application ID	VLAN ID	Priority	Simulate Bit	Show Live Data	Enable PC Simulation	Select all GN	Select all GP	Quality Value
IED_SISCO	IDevice1	IED_SISCODevice1/LLN0\$G0\$gocbBrkrDemo	GOOSE_Data	SISCO_AX54_51	2	4	<input type="checkbox"/>	<input type="checkbox"/>	<input type="checkbox"/>	<input type="checkbox"/>	<input type="checkbox"/>	Select
IED_TMW	CTL1	IED_TMWCTL1/LLN0\$G0\$gcbTMW	CB1GooseDS	TMW_Anvil_91	2	4	<input type="checkbox"/>	<input type="checkbox"/>	<input type="checkbox"/>	<input type="checkbox"/>	<input type="checkbox"/>	Select
SV_EFACEC	IO	SV_EFACECIO/LLN0\$G0\$SEFA_LS00_Go61	DSforGo61	EFA_LS00_61	2	4	<input type="checkbox"/>	<input type="checkbox"/>	<input type="checkbox"/>	<input type="checkbox"/>	<input type="checkbox"/>	Select
SV_NR	PIG001	SV_NRPIG001/LLN0\$G0\$gocb1	dsGOOSE1	NR_PCS902_A1	2	4	<input type="checkbox"/>	<input type="checkbox"/>	<input type="checkbox"/>	<input type="checkbox"/>	<input type="checkbox"/>	Select
SV_NR	PIG001	SV_NRPIG001/LLN0\$G0\$gocb0	dsGOOSE0	NR_PCS902_A0	2	4	<input type="checkbox"/>	<input type="checkbox"/>	<input type="checkbox"/>	<input type="checkbox"/>	<input type="checkbox"/>	Select
SV_SEL	CFG	SV_SELCFG/LLN0\$G0\$BKR_TRP	BKR_TRP	SEL_401L_41	2	4	<input type="checkbox"/>	<input type="checkbox"/>	<input type="checkbox"/>	<input type="checkbox"/>	<input type="checkbox"/>	Select
SV_SEL	CFG	SV_SELCFG/LLN0\$G0\$FLT_INIT	FLT_INIT	SEL_401L_40	2	4	<input type="checkbox"/>	<input type="checkbox"/>	<input type="checkbox"/>	<input type="checkbox"/>	<input type="checkbox"/>	Select
SV_SEL	CFG	SV_SELCFG/LLN0\$G0\$BFR_RST	BFR_Reset	SEL_401L_44	2	4	<input type="checkbox"/>	<input type="checkbox"/>	<input type="checkbox"/>	<input type="checkbox"/>	<input type="checkbox"/>	Select

Dataset Items	Data type	Default Value	Details from SCL file	Custom label	GN	I/O Usage	Use	GP	Use	Show live d.
3 - stVal	Boolean	0	SV_EFACEC.USER.GGIO1.Ind02.stVal(ST)	EFA DOBLE Start Fault	<input checked="" type="checkbox"/>	1	<input type="checkbox"/>	0	<input type="checkbox"/>	<input checked="" type="checkbox"/>
4 - q	Quality	G-00000000-P-00	SV_EFACEC.USER.GGIO1.Ind02.q(ST)	EFA RBRF OpEx	<input checked="" type="checkbox"/>	1	<input type="checkbox"/>	0	<input type="checkbox"/>	<input checked="" type="checkbox"/>
5 - general	Boolean	0	SV_EFACEC.PROT.SPBF1RBRF1.OpEx.general(ST)	EFA PTOC.Str	<input checked="" type="checkbox"/>	1	<input type="checkbox"/>	0	<input type="checkbox"/>	<input checked="" type="checkbox"/>
6 - q	Quality	G-00000000-P-00	SV_EFACEC.PROT.SPBF1RBRF1.OpEx.q(ST)	EFA PTRC.Op	<input checked="" type="checkbox"/>	1	<input type="checkbox"/>	0	<input type="checkbox"/>	<input checked="" type="checkbox"/>
7 - general	Boolean	0	SV_EFACEC.PROT.PHOC1PTOC1.Str.general(ST)	EFA Reset Demo	<input checked="" type="checkbox"/>	1	<input type="checkbox"/>	0	<input type="checkbox"/>	<input checked="" type="checkbox"/>
8 - q	Quality	G-00000000-P-00	SV_EFACEC.PROT.PHOC1PTOC1.Str.q(ST)		<input type="checkbox"/>	0	<input type="checkbox"/>	0	<input type="checkbox"/>	<input type="checkbox"/>
9 - general	Boolean	0	SV_EFACEC.PROT.SPTRC1PTRC1.Op.general(ST)		<input checked="" type="checkbox"/>	1	<input type="checkbox"/>	0	<input type="checkbox"/>	<input checked="" type="checkbox"/>
10 - q	Quality	G-00000000-P-00	SV_EFACEC.PROT.SPTRC1PTRC1.Op.q(ST)		<input type="checkbox"/>	0	<input type="checkbox"/>	0	<input type="checkbox"/>	<input type="checkbox"/>
11 - general	Boolean	0	SV_EFACEC.CTRL.CSWI1.OpCls.general(ST)		<input checked="" type="checkbox"/>	1	<input type="checkbox"/>	0	<input type="checkbox"/>	<input checked="" type="checkbox"/>

Configuring Doble F6150sv test set for Signal Inputs(GOOSE Subscription)



- Map selected data signals to **Inputs** (GN#) of F6150sv test set
- Verify “compare” values signal triggering for use during testing

Substation
F6 Input
F6 Output
PC GSE Simulator
Subscription Mapping
Notes

Dataset items available

GSE control block reference	Dataset name	GSE application ID	Label	Details from SCL file	Item no.	Data type
SV_EFACECIO/LLN0\$GO\$EFA_L500_Go61	DSforGo61	EFA_L500_61	EFA DOBLE Start Fault	USER.GGIO1.Ind02.stVal(ST)	3	Boolean
SV_EFACECIO/LLN0\$GO\$EFA_L500_Go61	DSforGo61	EFA_L500_61	EFA PTOC.Str	PROT.PHOC1PTOC1.Str.general(ST)	7	Boolean
SV_EFACECIO/LLN0\$GO\$EFA_L500_Go61	DSforGo61	EFA_L500_61	EFA PTRC.Op	PROT.SPTRC1PTRC1.Op.general(ST)	9	Boolean
SV_EFACECIO/LLN0\$GO\$EFA_L500_Go61	DSforGo61	EFA_L500_61	EFA RBRF.OpEx	PROT.SPBF1RBRF1.OpEx.general(ST)	5	Boolean
SV_EFACECIO/LLN0\$GO\$EFA_L500_Go61	DSforGo61	EFA_L500_61	EFA Reset Demo	CTRL.CSW11.OpCls.general(ST)	11	Boolean
SV_NRPIGO01/LLN0\$GO\$gocb1	dsGOOSE1	NR_PCS902_A1	NR DOBLE Fault Start	PIGO01.GOOOUTGGIO1.Ind2.stVal(ST)	2	Boolean
SV_NRPIGO01/LLN0\$GO\$gocb1	dsGOOSE1	NR_PCS902_A1	NR Reset Demo	PIGO01.GOOUTCsw11.OpCls.general(ST)	3	Boolean
SV_NRPIGO01/LLN0\$GO\$gocb0	dsGOOSE0	NR_PCS902_A0	NR PTOC2.Str	PIGO01.PTOC2.Str.general(ST)	2	Boolean
SV_NRPIGO01/LLN0\$GO\$gocb0	dsGOOSE0	NR_PCS902_A0	NR PTOC2.Op	PIGO01.PTOC2.Op.general(ST)	4	Boolean
SV_NRPIGO01/LLN0\$GO\$gocb0	dsGOOSE0	NR_PCS902_A0	NR PTRC.Op	PIGO01.PTRC1.Op.general(ST)	5	Boolean

Dataset item assigned + Add below

F6 Instrument	ID	Label	Details from SCL file	GSE control block reference	Dataset name	GSE application ID	Item no.	Data type	Compare	Value
F6150	GN1	EFA DOBLE Start Fa	USER.GGIO1.Ind02.stVal(ST)	SV_EFACECIO/LLN0\$GO\$EFA_L500_Go61	DSforGo61	EFA_L500_61	3	Boolean	=	1
F6150	GN2	NR DOBLE Fault Sta	PIGO01.GOOOUTGGIO1.Ind2.stVal(ST)	SV_NRPIGO01/LLN0\$GO\$gocb1	dsGOOSE1	NR_PCS902_A1	2	Boolean	=	1
F6150	GN3	EFA Reset Demo	CTRL.CSW11.OpCls.general(ST)	SV_EFACECIO/LLN0\$GO\$EFA_L500_Go61	DSforGo61	EFA_L500_61	11	Boolean	=	1
F6150	GN4	NR Reset Demo	PIGO01.GOOUTCsw11.OpCls.general(ST)	SV_NRPIGO01/LLN0\$GO\$gocb1	dsGOOSE1	NR_PCS902_A1	3	Boolean	=	1
F6150	GN5	EFA PTOC.Str	PROT.PHOC1PTOC1.Str.general(ST)	SV_EFACECIO/LLN0\$GO\$EFA_L500_Go61	DSforGo61	EFA_L500_61	7	Boolean	=	1
F6150	GN6	EFA PTRC.Op	PROT.SPTRC1PTRC1.Op.general(ST)	SV_EFACECIO/LLN0\$GO\$EFA_L500_Go61	DSforGo61	EFA_L500_61	9	Boolean	=	1
F6150	GN7	EFA RBRF.OpEx	PROT.SPBF1RBRF1.OpEx.general(ST)	SV_EFACECIO/LLN0\$GO\$EFA_L500_Go61	DSforGo61	EFA_L500_61	5	Boolean	=	1
F6150	GN8	NR PTOC2.Str	PIGO01.PTOC2.Str.general(ST)	SV_NRPIGO01/LLN0\$GO\$gocb0	dsGOOSE0	NR_PCS902_A0	2	Boolean	=	1

Configuring Doble F6150sv test set for Signal Output Simulation (GOOSE Publishing)



- Map selected GOOSE data signals to logic **Outputs** (GP#) of test set
- Verify “True value” and “False value” for signals simulated during testing

Substation F6 Input **F6 Output** PC GSE Simulator Subscription Mapping Notes

Dataset items available

GSE control block reference	Dataset name	GSE application ID	Label	Details from SCL file	Item no.	Data type
XCBR_DOBLESystem/LLN0\$GO\$gcb01	Dset1_CBStatus	DOBLE_F6150sv_20	DOBLE XCBR	C1CB1.CB1XCBR1.Pos.stVal(ST)	1	CodedEnum

Dataset item assigned + Add below

F6 Instrument	ID	Label	Details from SCL file	GSE control block reference	Dataset name	GSE application ID	Item no.	Data type	True value	False value	Delete
F6150	GP1	DOBLE XCBR	C1CB1.CB1XCBR1.Pos.stVal(ST)	XCBR_DOBLESystem/LLN0\$GO\$gcb0	Dset1_CBStatus	DOBLE_F6150sv	1	CodedEnum	2 (10)	1 (01)	X

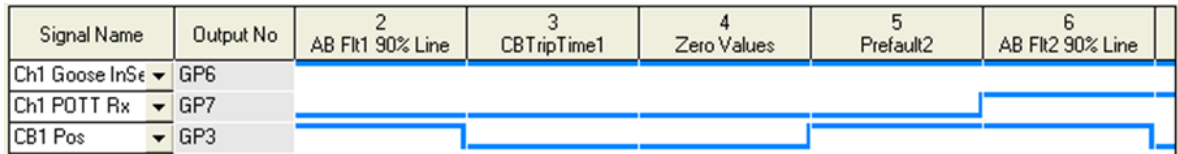

Configuring F6150sv test set for Simulation of Sampled Values



SV set number	1	2	3
SV ID	LINE_1 MU 01 01	BUS_A MU 02 01	TRAFO_1 MU 03 01
Dest. MAC Address	01:0C:CD:04:00:01	01:0C:CD:04:00:20	01:0C:CD:04:00:11
APPID (Hex)	4000	4020	4011
VLAN ID <small>Hex</small>	0	003	003
VLAN Priority	4	4	4
Simulated by test set	<input checked="" type="checkbox"/>	<input checked="" type="checkbox"/>	<input checked="" type="checkbox"/>
Time synchronization	Automatic	Local override	Unsynchronized
Quality			
Source	VA	VA	VA
Derived	<input type="checkbox"/>	<input type="checkbox"/>	<input type="checkbox"/>
Operator Blocked	<input type="checkbox"/>	<input type="checkbox"/>	<input type="checkbox"/>
Test	<input checked="" type="checkbox"/>	<input checked="" type="checkbox"/>	<input checked="" type="checkbox"/>
Source	Process	Process	Process
Inaccurate	<input type="checkbox"/>	<input type="checkbox"/>	<input type="checkbox"/>
Inconsistent	<input type="checkbox"/>	<input type="checkbox"/>	<input type="checkbox"/>
Old data	<input type="checkbox"/>	<input type="checkbox"/>	<input type="checkbox"/>
Failure	<input type="checkbox"/>	<input type="checkbox"/>	<input type="checkbox"/>
Oscillatory	<input type="checkbox"/>	<input type="checkbox"/>	<input type="checkbox"/>
Bad Reference	<input type="checkbox"/>	<input type="checkbox"/>	<input type="checkbox"/>
Out of range	<input type="checkbox"/>	<input type="checkbox"/>	<input type="checkbox"/>
Overflow	<input type="checkbox"/>	<input type="checkbox"/>	<input type="checkbox"/>
Validity	Good	Good	Good
	00 10 00 00 00 00 00	00 10 00 00 00 00 00	00 10 00 00 00 00 00
	<input checked="" type="checkbox"/> Same for all Sources	<input checked="" type="checkbox"/> Same for all Sources	<input checked="" type="checkbox"/> Same for all Sources

Import
SCL files

• SV sets for Substation
 • Simulate up to 3 sets of SV
 • Simultaneously for each test
 • Simulation flag
 • Synchronization
 (based on GPS signal)
 • Make Local & Global
 • Make Unsynchronized
 —
 • etc.

MMS Client, Reporting and Control



Client Simulator Server Simulator

View IED Details and Configuration reports

Discover remote IED Select IEDs for communication Save as SCL file Control operation

IED Explorer Configure Reports

LINE1(10.1.150.20)

- AutoControl
- AutoRec1
- AutoRec2
- AutoSynChk1
- AutoSynChk2
- CBControl
- CtICB1
 - CB1C1LO1
 - CB1CSWI1
 - CB1PTRC1
 - CB1XCBR1
 - CF
 - DC
 - ST
 - Beh
 - Health
 - Mod
 - EEHealth
 - Loc
 - OpCnt

LINE1(10.1.150.20).CtICB1.CB1XCBR1.ST.Pos - Switch Position

Data Name	Data Description	Value Description	Value	Type
CB1XCBR1.ST.Pos.stVal	Status value of data	Closed	2(10)	CODEENUM
CB1XCBR1.ST.Pos.q	Quality of the attribute(s) representing the value of data		G-00000000-P-00	BIT_STRING
CB1XCBR1.ST.Pos.t	Timestamp of the last change in data value or q		2018-05-24 16:23:08.402	UTC_TIME

Data Name **Data Description** **Description of values and enumerations** **Data Values** Write to server

Watch window Client activity log

Watch 1 + - Read value from IED Refresh every 5 (s)

Data Name	Data Description	Value Description	Value	Data Type	
LINE1.System.LLN0.ST.Beh.stVal	Status value of data	test-blocked	4	INTEGER	x
LINE1.System.LPHD1.ST.Sim.stVal	Status value of data	TRUE	1	BOOL	x
LINE1.System.LGOS1.ST.Beh.stVal	Status value of data	test-blocked	4	INTEGER	x
LINE1.ProtOvCur.OcpPTOC1.ST.Op.general	Logical OR of the phase values, for trip, start or operate	FALSE	0	BOOL	x
LINE1.ProtOvCur.OcpPTRC7.ST.Op.general	Logical OR of the phase values, for trip, start or operate	FALSE	0	BOOL	x

Watch window – Automatically polls and updates selected data

Control User Interface

- Test sequences of control operations with ease
 - **Non-expert mode** hides/disable buttons and fields and allows only valid operations
 - **Expert mode** enables everything and allows testing of invalid sequences
- Filters for easy selection of objects
- Support all control models –
 - **status** only
 - **direct** with normal or enhanced security
 - **SBO (select-before-operate)** with normal security
 - **direct** with enhanced security
 - **SBO** with enhanced security
- Test control operations with checks of **interlocking** and **synchronization**
- Perform tests with IEDs in test mode with the control sequence **Test flag** set
- Status info of requests and responses

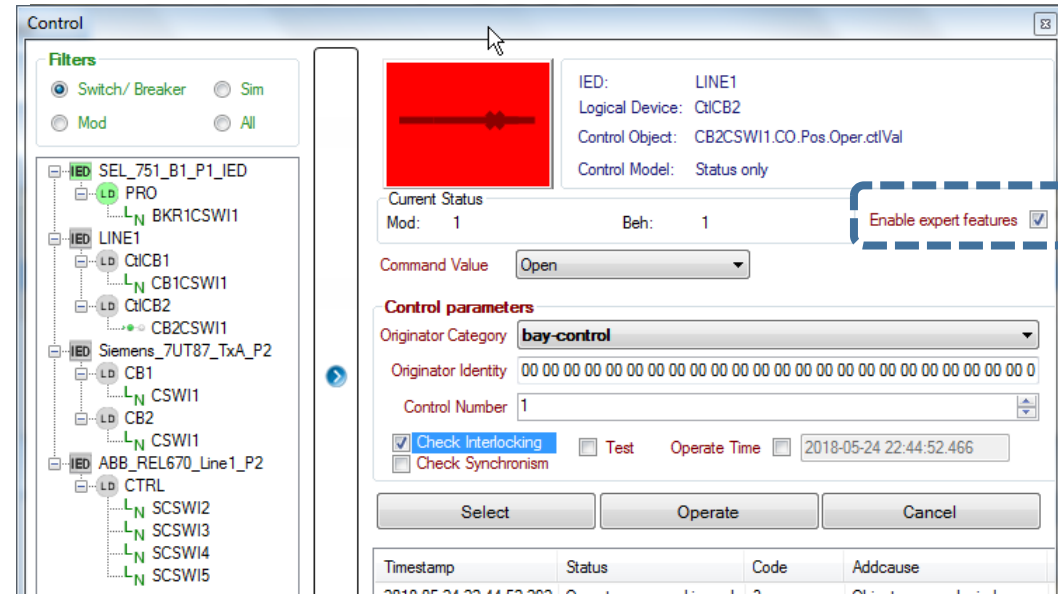

User Control of IED's modes for Testing

- LD or LN.Mod
 - on (1)
 - blocked (2)
 - test (3)
 - test-blocked (4)
 - off (5)

The screenshot shows the 'Control' window for IED LINE1. The 'Filters' section has 'Mod' selected. The tree view shows 'IED LINE1' expanded with sub-items like 'AutoRec1', 'AutoRec2', 'AutoSynChk1', 'AutoSynChk2', 'CtICB1Fail', 'CtICB2Fail', and 'ProtDis'. A large orange box displays 'test-blocked'. The 'Current Status' section shows 'Mod: 4' and 'Beh: 4'. The 'Command Value' dropdown is set to 'test-blocked (4)'. Metadata includes 'IED: LINE1', 'Logical Device: System', 'Control Object: LLN0.CO.Mod.Oper.ctlVal', and 'Control Model: Direct with normal security'. There are 'Operate' and 'Cancel' buttons at the bottom.

- LPHD.Sim
 - false (0)
 - true (1)

The screenshot shows the 'Control' window for IED LINE1. The 'Filters' section has 'Sim' selected. The tree view shows 'IED LINE1' expanded with sub-items like 'System', 'LPHD1', 'Sim', 'GE_P645_TxA_P1', and 'ABB_REL670_Line1_P2'. A large red box displays 'true'. The 'Current Status' section shows 'Mod: 1' and 'Beh: 1'. The 'Command Value' dropdown is set to 'true (1)'. Metadata includes 'IED: LINE1', 'Logical Device: System', 'Control Object: LPHD1.CO.Sim.Oper.ctlVal', and 'Control Model: Direct with normal security'. There are 'Operate' and 'Cancel' buttons at the bottom.

Real-time Data Visualization and Recording – GOOSE, Reports, Sampled Values



Live Tabular view - Selected signals only or All signals
Identify identical sources (real & test); Sim = true or false

Tabular		Graphs_Recording	Annunciator						
GSE	Report								
GSE control block reference	Dataset name	Item...	GSE application ID	SCL Details	Data type	Value	Time of last val...	Last Mag...	Last Mag...
LINE1System.LLN0SG0gcb03	Da3_FCD_A_FCD	11	LINE1System.LLN0SG0gcb03	CICB1.CB1XCBR1.Pos.t(ST)	UTCTimeStamp	2016/08/07 22:13:36.826 2a	2016/08/07 22:13:36.826 2a	7	5493
LINE1System.LLN0SG0gcb03	Da3_FCD_A_FCD	4	LINE1System.LLN0SG0gcb03	ProtSchem.DisSchPTRCS.Op.g(ST)	Quality	G-0000000-P-10	2016/08/07 22:13:36.826 2a	7	5493
LINE1System.LLN0SG0gcb03	Da3_FCD_A_FCD	3	LINE1System.LLN0SG0gcb03	ProtSchem.DisSchPTRCS.Op.g(ST)	Boolean	0	2016/08/07 22:13:36.826 2a	7	5493
LINE1System.LLN0SG0gcb03	Da3_FCD_A_FCD	2	LINE1System.LLN0SG0gcb03	ProtDis.DisPTRCS.Op.g(ST)	Quality	G-0000000-P-10	2016/08/07 22:13:36.826 2a	7	5493
LINE1System.LLN0SG0gcb03	Da3_FCD_A_FCD	1	LINE1System.LLN0SG0gcb03	ProtDis.DisPTRCS.Op.g(ST)	Boolean	0	2016/08/07 22:13:36.826 2a	7	5493
LINE1System.LLN0SG0gcb03	Da3_FCD_A_FCD	5	LINE1System.LLN0SG0gcb03	ProtSchem.DisSchPTRCS.Op.t(ST)	UTCTimeStamp	2016/08/07 22:13:38.536 2a	2016/08/07 22:13:38.536 2a	7	5493

Watch windows in Client/Server – Local + Global

Watch window Client activity log

Watch 1 Read value from IED Refresh every 5 (s)

Data Name	Data Description	Value Description	Value	Data Type
LINE1.System.LLN0.ST.Beh.stVal	Status value of data	test-blocked	4	INTEGER
LINE1.System.LPHD1.ST.Sim.stVal	Status value of data	TRUE	1	BOOL
LINE1.System.LGOS1.ST.Beh.stVal	Status value of data	test-blocked	4	INTEGER
LINE1.ProvOcur.OcpPTOC1.ST.Op.g(ST)	Logical OR of the phase values, for trip, start or operate	FALSE	0	BOOL

Oscillograph views – GOOSE, Report, SV; Save COMTRADE

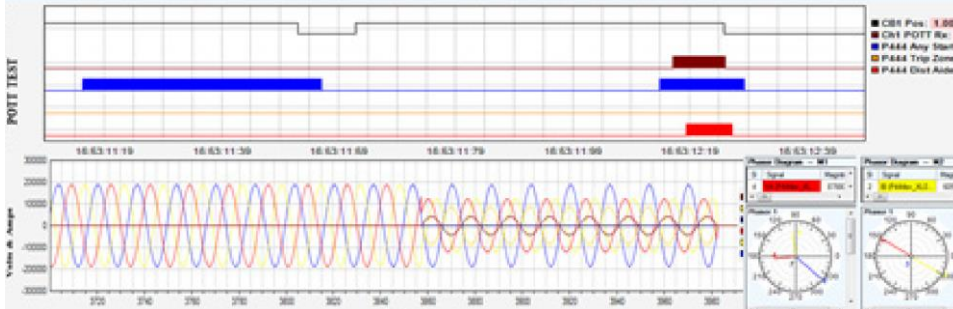

Annunciator view - with animated widgets
(user configurable); Detect if GOOSE is disconnected



Logging view- GOOSE & Reports + dataset details

GSE Log Report Log Time aligned view Polling Log

GOOSE GSSE All Expressions Open Save Clear Refresh Refresh in every 1 sec

Last Msg. Arrival time	Time of last value change	GSE Control Ref	Dataset Name	Application ID	State Change No.	Seq. Number	Simulate Bit	Need comm.
2016/08/08 01:19:56.896	2016/08/07 22:13:38.584	LINE1System.LLN0SG0gcb03	Da3_FCD_A_FCD	LINE1System.LLN0S	7	4004	False	False
2016/08/08 01:19:56.891	2016/08/07 22:13:38.582	LINE1System.LLN0SG0gcb02	Da2_FCD	LINE1System.LLN0S	11	4004	False	False
2016/08/08 01:19:56.888	2016/08/07 22:13:38.581	LINE1System.LLN0SG0gcb01	Da1_FCD	LINE1System.LLN0S	11	4004	False	False
2016/08/08 01:19:54.899	2016/08/07 22:13:38.584	LINE1System.LLN0SG0gcb03	Da3_FCD_A_FCD	LINE1System.LLN0S	7	4004	False	False
2016/08/08 01:19:54.893	2016/08/07 22:13:38.582	LINE1System.LLN0SG0gcb02	Da2_FCD	LINE1System.LLN0S	11	4004	False	False
2016/08/08 01:19:54.885	2016/08/07 22:13:38.581	LINE1System.LLN0SG0gcb01	Da1_FCD	LINE1System.LLN0S	11	4004	False	False
2016/08/08 01:19:52.890	2016/08/07 22:13:38.584	LINE1System.LLN0SG0gcb03	Da3_FCD_A_FCD	LINE1System.LLN0S	7	4004	False	False

Dataset info	Dataset Item	Item No.	Data type	Value
GSE Control Ref	LINE1System.LLN0SG0gcb01	1	Boolean	0
Application ID	LINE1System.LLN0SG0gcb01	2	Quality	G-0000000-P-10
Dataset Name	Da1_FCD_A	3	Boolean	0
Config Rev	1	4	Quality	G-0000000-P-10
Needs Commissioning	False	5	Boolean	0
Simulate Bit	False	6	Quality	G-0000000-P-10
Multicast MAC Address	01-00-0d-01-00-00	7	Boolean	0
App ID	3F01	8	Quality	G-0000000-P-10
Time of last value change	2016/08/07 22:13:38.581	9	Boolean	0
State Change No.	11	10	Quality	G-0000000-P-10
Seq. Number	4004	11	Boolean	0
VLAN ID	0	12	Quality	G-0000000-P-10
VLAN Priority	0	13	Code/Enum	3011
Data Item Count	14			

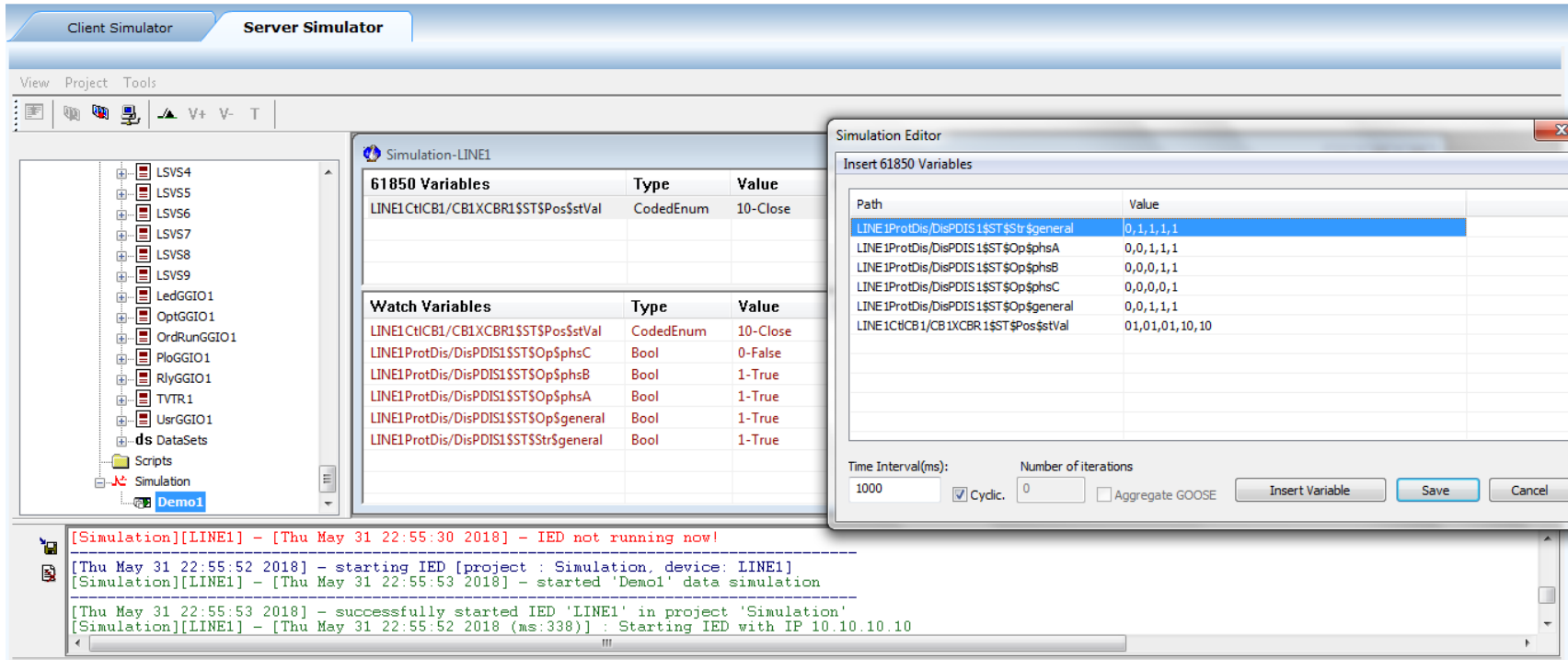

Client Simulator | **Server Simulator**

View Project Tools

Simulation-LINE1

61850 Variables	Type	Value
LINE1CHCB1/CB1XCBR1\$ST\$Pos\$stVal	CodedEnum	10-Close

Watch Variables	Type	Value
LINE1CHCB1/CB1XCBR1\$ST\$Pos\$stVal	CodedEnum	10-Close
LINE1ProtDis/DisPDIS1\$ST\$Op\$phsC	Bool	0-False
LINE1ProtDis/DisPDIS1\$ST\$Op\$phsB	Bool	1-True
LINE1ProtDis/DisPDIS1\$ST\$Op\$phsA	Bool	1-True
LINE1ProtDis/DisPDIS1\$ST\$Op\$general	Bool	1-True
LINE1ProtDis/DisPDIS1\$ST\$Str\$general	Bool	1-True

Simulation Editor

Insert 61850 Variables

Path	Value
LINE1ProtDis/DisPDIS1\$ST\$Str\$general	0,1,1,1,1
LINE1ProtDis/DisPDIS1\$ST\$Op\$phsA	0,0,1,1,1
LINE1ProtDis/DisPDIS1\$ST\$Op\$phsB	0,0,0,1,1
LINE1ProtDis/DisPDIS1\$ST\$Op\$phsC	0,0,0,0,1
LINE1ProtDis/DisPDIS1\$ST\$Op\$general	0,0,1,1,1
LINE1CHCB1/CB1XCBR1\$ST\$Pos\$stVal	01,01,01,10,10

Time Interval(ms): 1000 Number of iterations: 0

Cyclic Aggregate GOOSE

Insert Variable Save Cancel

```
[Simulation][LINE1] - [Thu May 31 22:55:30 2018] - IED not running now!  
[Thu May 31 22:55:52 2018] - starting IED [project : Simulation, device: LINE1]  
[Simulation][LINE1] - [Thu May 31 22:55:53 2018] - started 'Demo1' data simulation  
[Thu May 31 22:55:53 2018] - successfully started IED 'LINE1' in project 'Simulation'  
[Simulation][LINE1] - [Thu May 31 22:55:52 2018 (ms:338)] : Starting IED with IP 10.10.10.10
```

- Use for simulating missing IEDs during any testing phase

- Use to simulate special test conditions

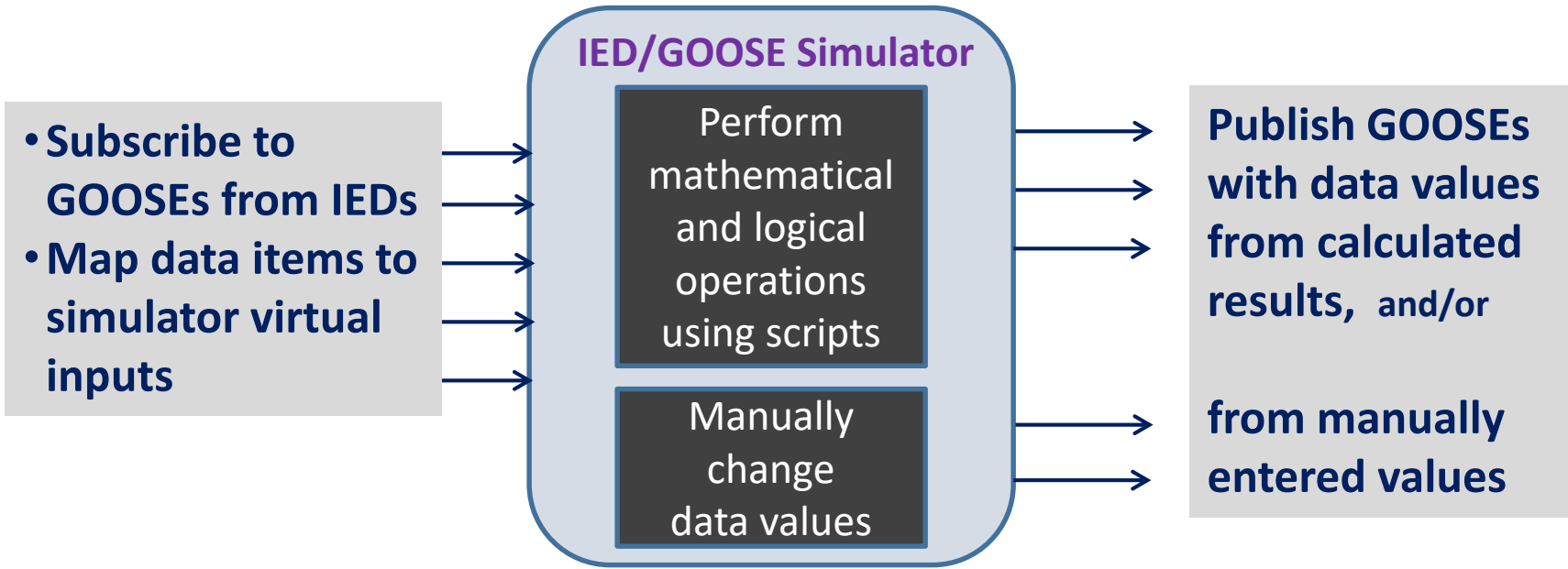

- Use for simulating missing IEDs during any testing phase

- Use to simulate special test conditions

Protection Test software solutions

Test | Test Points | Test Configuration | Test Elements | Reports | Notebook

Test Method: Constant Source Z

Test Voltage [V]: Desired _____ Actual 118709.68

Test Current [A]: _____ 1854.839

Test Points and Results

	AN	BN	CN	AB	BC	CA	ABC
Z	7.192	80.00	89.9	Zn1	20.0	26.8	Pass 0.0
Angle	8.808	80.00	110.1	Zn1	320.0	316.4	Pass 288
%Zone	12.901	80.00	80.000	Zn2	320.0	316.4	Pass 288
Zone	14.384	80.00	89.9	Zn2	320.0	316.4	Pass 288
t exp [ms]	17.616	80.00	110.1	Zn2	1020.0	1024.7	Pass 918
t act [ms]	32.000	80.00	80.000	Zn3	1020.0	1026.8	Pass 918
Eval							
t mir							

Clear Test Results | Oscillograph

Run Tests: Multi-point Shots, Selected Point Only, Spiral

Fault Type: AN, BN, CN, AB, BC, CA, ABC

Show Phasgrs: No Error calculation, No Evaluation

Error to be calculated: Percentage, Absolute

Graph Type: R-X Plane, Z-T Plane

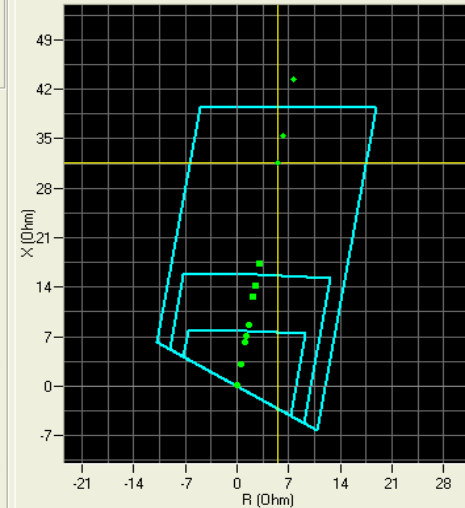

- Visual modeling and testing to verify settings and characteristics
- Avoid changing settings and signal mappings
- Smart testing targets specific functional elements by applying correct voltages and currents

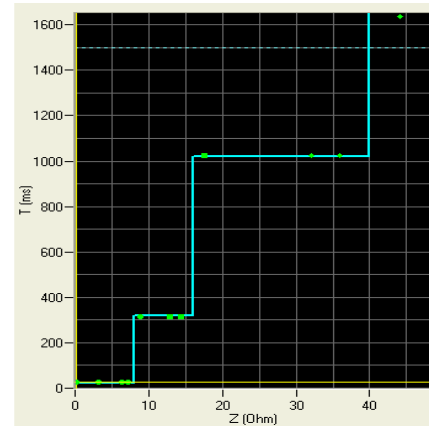

- Automatically identifies the elements that operated based on measured operate times and/or status of data signal

Protection Test software solutions



NewRelay1: NewTestPlan1 - Protection Suite

Files Relay, Device Test Plan: NewTestPlan1 Test 2: New_State Simulation_1 Results/History Reports Instrument Tools F6 Control Panel Preferences Help

Define test parameters, measurement ranges and triggering for State Simulation test. Edit... Save Tools... Run Test

States Summary State Details Sources Worksheet Inputs Timers Outputs Power System Model Signals Notes Recording

Power System Impedance Model

Element	Type	Positive Sequence		Zero Sequence	
		Magnitude	Angle	Magnitude	Angle
Line 1		1.900	90.000	6.560	90.000
Line 2		1.900	90.000	6.560	90.000
Mutual		(Line 1 Line 2)		1.000	90.000
Tap Line		1.900	90.000	6.560	90.000
S1	Zs	0.740	90.000	0.530	90.000
S2	Zs	3.600	90.000	2.120	90.000
S3	Zs	3.600	90.000	2.120	90.000

Source Voltages

Source	Magnitude	Angle
S1	66.400	5.000
S2	66.400	3.000
S3	66.400	0.000

PSM Control

Place States

Live Sync PSM States

Relay: A

Model Configuration: Parallel Line with Tap

Display

Coordinates: Polar
Pri/Sec: Secondary

Fault Model

Fault Type: Ph-G
Rfg: 0.010 Ω
Rf: 0.005 Ω

Fault Location

Line 1: 30.00 %
Tap Location: 50.00 %

Fault Conditions and Load Flow (secondary values)

Relay A: Prefault/Postfault, Fault Conditions
Relay B: Prefault/Postfault, Fault Conditions
Relay C: Prefault/Postfault, Fault Conditions
Relay D: Prefault/Postfault, Fault Conditions

Battery 0 0 1 Tests 2. New_State Simulation_1 (State Simulation) Show latest results with test conditions Time ms

Protection Suite sw

- Power system models
- Transient testing

Test Preparation for Ensuring Security and Efficiency

- Import SCD file
- Divide substation into manageable sub-systems
- Identify standard or similar sub-systems

- Identify and select related IEDs for each PAC sub-system
- Matrix of GOOSE messages and signals
 - Publishing
 - Subscriptions/external references
- SV messages

- Develop 61850 Test configuration files
- System conditions
 - Normal
 - Simulation / Test

- Map GOOSE Signals to F6150sv Logic I/O
- Simulation: sequence tables and scripts
- Live Data visualization and recording (GOOSE, SV, Report)
- Client config. for control, report, watch/polling

- Provide special attention to test isolation and security to prevent inadvertent operation of devices in normal operation while performing test on other devices.
- Thoroughly test and vet configuration files and test plans
- Document configuration files and test plans and provide clear procedures and instructions for test personnel

- Develop automated test plans
- Normal and test conditions

- Functional element tests
- Multi-element tests of main functions
- Fault conditions and control sequences
- Multi-IED scheme tests

- Collection of well-organized files and test plans
- Select, use, reuse applicable files and plans for:

- Factory Acceptance Tests
- Commissioning tests
- Maintenance tests

Fully tested and properly documented configuration and test files promotes efficiency and ensures security during testing